

EX-30 SERIES

New

Threaded Miniature Photoelectric Sensor **Amplifier Built-in**



The next-generation new form series. A new alternative to fiber sensors.



Simpler design

All you need to do is make a $\phi 4$ mm $\phi 0.157$ in hole where you would like to stop or check the workpiece ($\phi 6$ mm $\phi 0.236$ in hole for reflective type). Furthermore, the center of the sensing axis is the same as the center of the mounting hole, which makes it much easier to set the sensing position.



Center of sensing axis
Center of mounting hole

Can be installed in the same way as standard fibers

The EX-30 series can be screw-mounted (M4 for thru-beam type, M6 for reflective type) in the same way as standard fiber sensors. This means that they can be inserted into production lines in exactly the same way as conventional high-priced fiber sensors.

M4 ▶
Thru-beam type (EX-31□)
(Reflective type: M6)



New design solves all weak points of fiber sensors

The EX-30 series solves all of the difficulties associated with fiber sensors, such as:

- Difficulty finding a suitable place for the amplifier
- Fragility of the fiber
- Extra space needed because of difficulty in bending the fiber
- The nuisance of having to use a protective tube to prevent fiber breakages

No amplifier needed

The amplifier is built in, so a separate amplifier is not required.

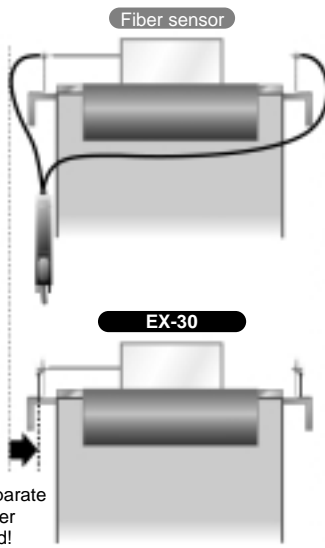

Unbreakable

A cabtyre cable is used, so that the sensor cable will not break like conventional fibers.



Takes up very little space

Unlike conventional fibers, bending radius is not a problem, so that the sensor can be securely installed alongside conveyors.

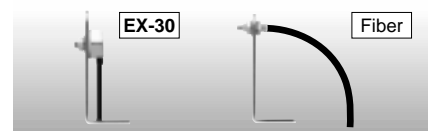

No protective tube needed

The EX-30 series has high bending strength, so that the protective tube used to protect conventional fiber from breakage are not needed. This also adds up to excellent cost performance.



APPLICATIONS

Detecting IC height

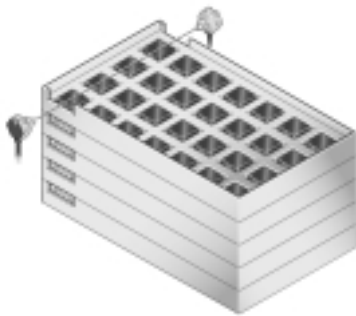

Detecting quantity of labels in label magazine



Checking IC pins (using slit masks)

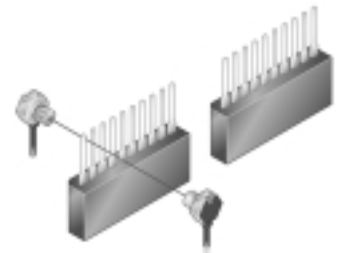

Single-point tightening cuts down on installation work by half

Conventional photoelectric sensors required four (for thru-beam type) or two (for reflective type) mounting holes and screws to be used. However, the **EX-30** series is installed with a single screw, thus cutting down on installation work by half.

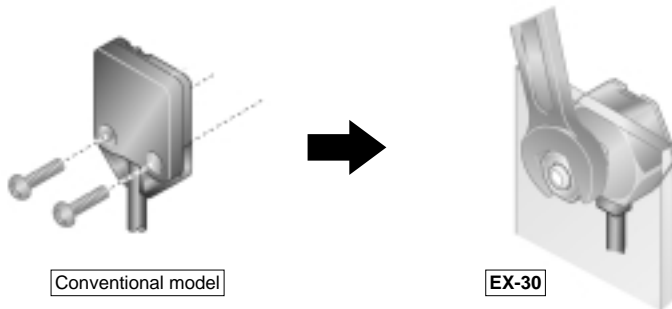

Conventional model

EX-30

Long sensing range

The **EX-30** series achieves long distance sensing [thru-beam type: 500 mm 19.685 in, reflective type: 50 mm 1.969 in.]

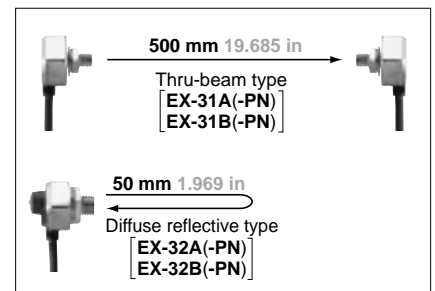

Incorporates a sensitivity adjuster (Reflective type only)

The sensor incorporates a sensitivity adjuster. It is convenient when you need fine adjustment.



Sensitivity adjuster

Bright 2-color indicator

A bright 2-color indicator has been incorporated in all types.



Operation indicator (Orange)

Stability indicator (Green)

Waterproof

The sensor can be hosed down because of its IP67 construction.

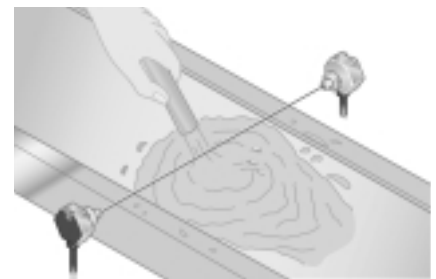

Note: However, take care that if it is exposed to water splashes during operation, it may detect a water drop itself.

High response speed of 0.5 ms

The same high response speed of 0.5 ms as fiber sensor amplifiers is provided, making these sensors ideal for sensing small objects, counting objects that are moving quickly and positioning items such as circuit boards.

Globally useable

It conforms to the EMC Directive and obtains UL Recognition. Moreover, PNP output type which is much demand in Europe, is also available.



Conforming to EMC Directive



UL Recognition (Excluding 5 m cable length type)

Separate slit masks also available

A slit mask can be attached to narrow the beam width down to $\phi 1$ mm $\phi 0.039$ in to allow sensing of very small objects.

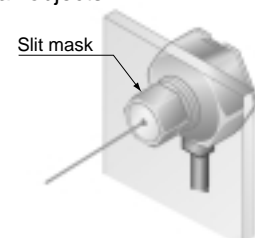

Slit mask

Low price

The recommended price is much lower than the price for fiber sensor sets.

EX-30

ORDER GUIDE

Type	Appearance	Sensing range	Model No.	Output	Output operation
Thru-beam			EX-31A	NPN open-collector transistor	Light-ON
			EX-31B		Dark-ON
			EX-31A-PN	PNP open-collector transistor	Light-ON
			EX-31B-PN		Dark-ON
Diffuse reflective			EX-32A	NPN open-collector transistor	Light-ON
			EX-32B		Dark-ON
			EX-32A-PN	PNP open-collector transistor	Light-ON
			EX-32B-PN		Dark-ON

5 m 16.404 ft cable length type

5 m 16.404 ft cable length type (standard: 2 m 6.562 ft) is also available.

• Model No. Table

Type	Standard type	5 m 16.404 ft cable length type
Thru-beam	EX-31A	EX-31A-C5
	EX-31B	EX-31B-C5
Diffuse reflective	EX-32A	EX-32A-C5
	EX-32B	EX-32B-C5

OPTION

Designation	Model No.	Description	
Slit mask (For thru-beam type sensor only)	OS-EX30-1 (Slit size ϕ 1 mm) (ϕ 0.039 in)	Slit on one side	<ul style="list-style-type: none"> Sensing range: 200 mm 7.874 in Min. sensing object: ϕ 2 mm ϕ 0.079 in
		Slit on both sides	<ul style="list-style-type: none"> Sensing range: 150 mm 5.906 in Min. sensing object: ϕ 1 mm ϕ 0.039 in

Note: One slit and two spacers are provided per set. Two sets are required when installing on both sides.

Slit mask • OS-EX30-1

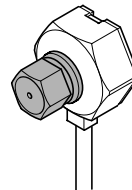

SPECIFICATIONS

Item	Model No.	Type	Thru-beam		Diffuse reflective	
		NPN output	EX-31A	EX-31B	EX-32A	EX-32B
		PNP output	EX-31A-PN	EX-31B-PN	EX-32A-PN	EX-32B-PN
Sensing range			500 mm 19.685 in		50 mm 1.969 in (Note)	
Sensing object			φ2 mm φ0.079 in or more opaque object		Opaque, translucent or transparent object	
Hysteresis			—		15 % or less of operation distance	
Repeatability (perpendicular to sensing axis)			0.05 mm 0.002 in or less		0.5 mm 0.020 in or less	
Supply voltage			12 to 24 V DC ± 10 % Ripple P-P10 % or less			
Current consumption			Emitter: 10 mA or less, Receiver: 15 mA or less		20 mA or less	
Output			<NPN output type> NPN open-collector transistor • Maximum sink current: 50 mA • Applied voltage: 30 V DC or less (between output and 0 V) • Residual voltage: 1 V or less (at 50 mA sink current) 0.4 V or less (at 16 mA sink current)		<PNP output type> PNP open-collector transistor • Maximum source current: 50 mA • Applied voltage: 30 V DC or less (between output and + V) • Residual voltage: 1 V or less (at 50 mA source current) 0.4 V or less (at 16 mA source current)	
	Utilization category		DC-12 or DC-13			
	Output operation		Light-ON	Dark-ON	Light-ON	Dark-ON
	Short-circuit protection		Incorporated			
Response time			0.5 ms or less			
Operation indicator			Orange LED (lights up when the output is ON)(incorporated on the receiver for thru-beam type)			
Stability indicator			Green LED (lights up under stable light received condition or stable dark condition, incorporated on the receiver)		Green LED (lights up under stable light received condition or stable dark condition)	
Sensitivity adjuster			—		Continuously variable adjuster	
Environmental resistance	Pollution degree		3 (Industrial environment)			
	Protection		IP67 (IEC)			
	Ambient temperature		- 25 to + 55 °C - 13 to + 131 °F (No dew condensation or icing allowed), Storage: - 30 to + 70 °C - 22 to + 158 °F			
	Ambient humidity		35 to 85 % RH, Storage: 35 to 85 % RH			
	Ambient illuminance		Sunlight: 10,000 lx at the light-receiving face, Incandescent light: 3,000 lx at the light-receiving face			
	EMC		EN 50081-2, EN 50082-2, EN 60947-5-2			
	Voltage withstandability		1,000 V AC for one min. between all supply terminals connected together and enclosure			
	Insulation resistance		20 MΩ, or more, with 250 V DC megger between all supply terminals connected together and enclosure			
	Vibration resistance		10 to 500 Hz frequency, 3 mm 0.118 in amplitude (20 G max.) in X, Y and Z directions for two hours each			
Shock resistance		500 m/s ² acceleration (50 G approx.) in X, Y and Z directions for three times each				
Emitting element			Red LED (modulated)			
Material			Enclosure: Die-cast zinc(Nickel plated), Lens: Polycarbonate [EX-32□(-PN): Acrylic], Enclosure cover: Polycarbonate			
Cable			0.1 mm ² 3-core (thru-beam type sensor emitter: 2-core) cabtyre cable, 2 m 6.562 ft long			
Cable extension			Extension up to total 50 m 164.042 ft is possible with 0.3 mm ² , or more, cable (thru-beam type: both emitter and receiver).			
Weight			Emitter: 20 g approx., Receiver: 20 g approx.		20 g approx.	
Accessories			Nut: 2 pcs., Toothed lock washer: 2 pcs.		Nut: 1 pc., Toothed lock washer: 1 pc.	

Note: The sensing range is specified of white non-glossy paper (100 × 100 mm 3.937 × 3.937 in) as the object.

EX-30

I/O CIRCUIT AND WIRING DIAGRAMS

NPN output type

I/O circuit diagram

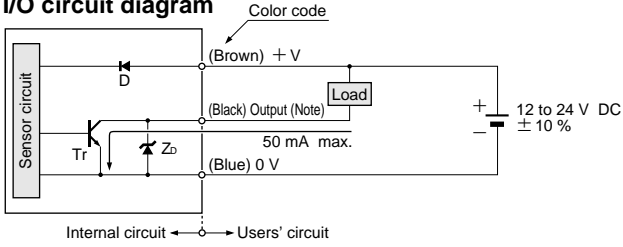

Wiring diagram

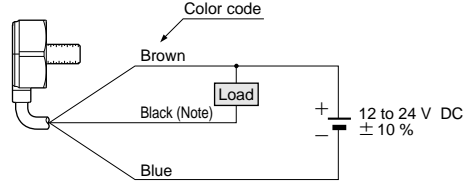

Note: The emitter of the thru-beam type sensor does not incorporate the output.

Symbols ... D : Reverse supply polarity protection diode
 ZD : Surge absorption zener diode
 Tr : NPN output transistor

Note: The emitter of the thru-beam type sensor does not incorporate the black wire.

PNP output type

I/O circuit diagram

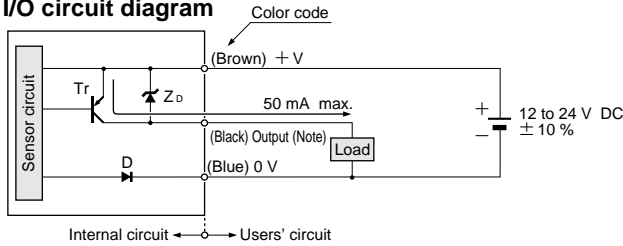

Wiring diagram

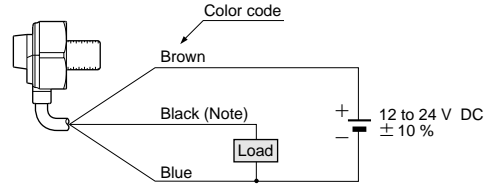

Note: The emitter of the thru-beam type sensor does not incorporate the output.

Symbols ... D : Reverse supply polarity protection diode
 ZD : Surge absorption zener diode
 Tr : PNP output transistor

Note: The emitter of the thru-beam type sensor does not incorporate the black wire.

SENSING CHARACTERISTICS (TYPICAL)

EX-31 Thru-beam type

Parallel deviation

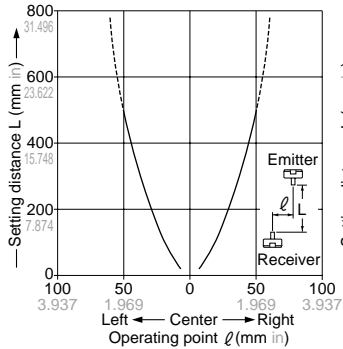

Angular deviation

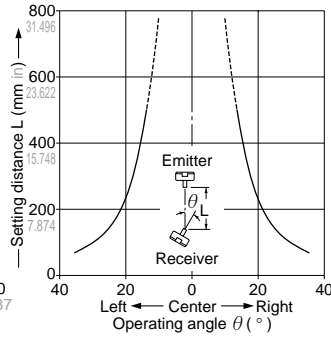

Parallel deviation with slit mask on one side

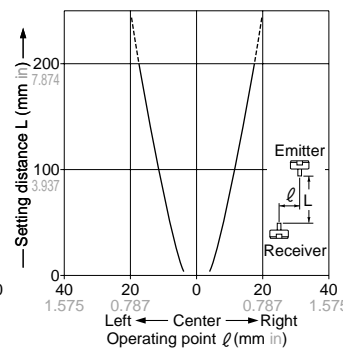

Parallel deviation with slit masks on both sides

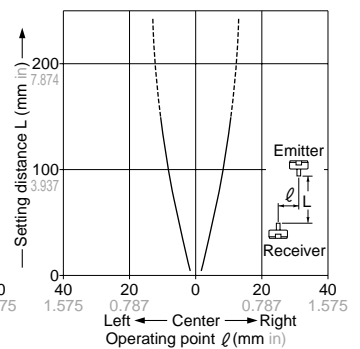

EX-31 Thru-beam type

Correlation between setting distance and excess gain

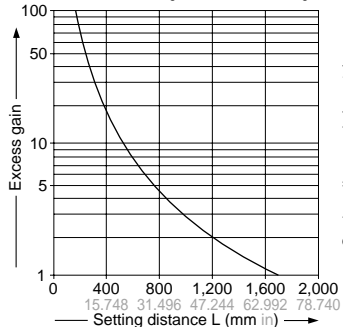

EX-32 Diffuse reflective type

Sensing field

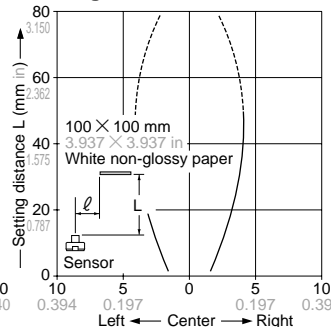

Correlation between sensing object size and sensing range

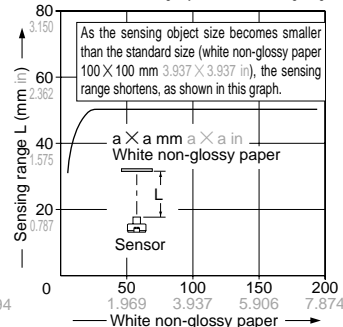

Correlation between setting distance and excess gain

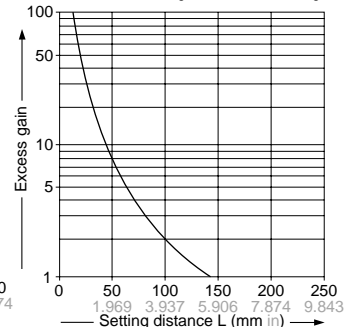

PRECAUTIONS FOR PROPER USE

Refer to p.1135~ for general precautions.

 This product is not a safety sensor. Its use is not intended or designed to protect life and prevent body injury or property damage from dangerous parts of machinery. It is a normal object detection sensor.

Part description

EX-31□, EX-31□-PN

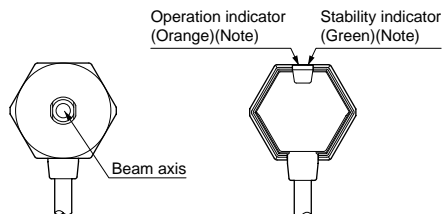

Note: Not incorporated on emitter.

EX-32□, EX-32□-PN

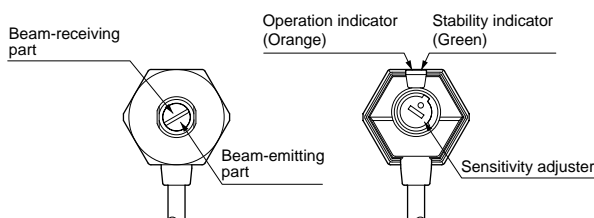



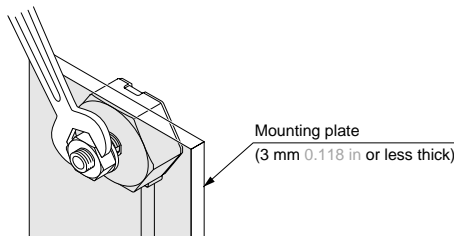

Mounting

- Mount the sensor on a mounting plate 3 mm 0.118 in or less thick, using the enclosed nut and toothed lock washer. When tightening the nut, hold the sensor with hand or a spanner and make sure that the tightening torque is 0.6 N·m [EX-32□(-PN): 1.0 N·m] or less. Do not tighten the sensor itself with a spanner, etc.



Sensitivity adjustment (Diffuse reflective type sensor only)

Step	Sensitivity adjuster	Description
①		Turn the sensitivity adjuster fully counterclockwise to the minimum sensitivity position.
②		In the light received condition, turn the sensitivity adjuster slowly clockwise and confirm the point (A) where the sensor enters the 'Light' state operation.
③		In the dark condition, turn the sensitivity adjuster further clockwise until the sensor enters the 'Light' state operation and then bring it back to confirm point (B) where the sensor just returns to the 'Dark' state operation. <i>If the sensor does not enter the 'Light' state operation even when the sensitivity adjuster is turned fully clockwise, this extreme position is point (B).</i>
④		The position at the middle of points (A) and (B) is the optimum sensing position.

Note: Use the attached adjusting screwdriver to turn the adjuster slowly. Turning with excessive strength will damage the adjuster.

Stability indicator

- The stability indicator (green) lights up when the incident light intensity has sufficient margin with respect to the operation level. If the incident light intensity level is such that the stability indicator lights up, stable sensing can be done without the light received operation and the light interrupted operation being affected by a change in ambient temperature or supply voltage.

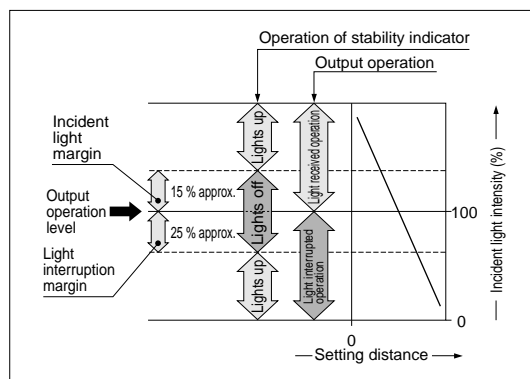

Wiring

- Make sure that the power supply is off while wiring.
- Verify that the supply voltage variation is within the rating.
- If power is supplied from a commercial switching regulator, ensure that the frame ground (F.G.) terminal of the power supply is connected to an actual ground.
- In case noise generating equipment (switching regulator, inverter motor, etc.) is used in the vicinity of this product, connect the frame ground (F.G.) terminal of the equipment to an actual ground.
- Extension up to total 50 m 164.042 ft (thru-beam type: both emitter and receiver) is possible with 0.3 mm², or more, cable. However, in order to reduce noise, make the wiring as short as possible.
- Do not run the wires together with high-voltage lines or power lines or put them in the same raceway. This can cause malfunction due to induction.
- Make sure to use an isolation transformer for the DC power supply. If an auto-transformer (single winding transformer) is used, this product or the power supply may get damaged.
- In case a surge is generated in the used power supply, connect a surge absorber to the supply and absorb the surge.

Optional slit mask (Thru-beam type only)

- Apply the optional slit mask (OS-EX30-1) when detecting small objects or for increasing the accuracy of sensing position. However, the sensing range is reduced when the slit mask is mounted.

Mounting method

- Insert the sensor into the mounting plate.
- Fit the washer and spacers enclosed with the slit mask. Note that the number of spacers to be fitted differs with the mounting plate thickness, as given in the table below. (Note)
- Mount the slit mask. Make sure that the tightening torque is 0.6 N·m or less.

Note: If the mounting plate thickness falls within the values mentioned in the table below, use the number of spacers that represents the thickness that comes closest to the actual thickness of the mounting plate being used. There will be no effect on the sensor if the slit comes out in the front because of the spacers.

Mounting plate thickness	No. of spacers
3 mm 0.118 in	0 pc.
2 mm 0.079 in	1 pc.
1 mm 0.039 in	2 pcs.

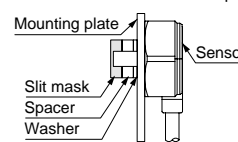

EX-30

PRECAUTIONS FOR PROPER USE

Refer to p.1135~ for general precautions.

Others

- Do not use during the initial transient time (50 ms) after the power supply is switched on.
- Take care that the sensor is not directly exposed to fluorescent light from a rapid-starter lamp or a high frequency lighting device, as it may affect the sensing performance.
- Avoid dust, dirt, and steam.
- Take care that the sensor does not come in direct contact with water, oil, grease, or organic solvents, such as, thinner, etc.
- In case of using the sensor at a place where static electricity is generated, use a metal mounting plate. Also, ensure to ground the mounting plate.

DIMENSIONS (Unit: mm in) The CAD data in the dimensions can be downloaded from the SUNX website: <http://www.sunx.co.jp/>

EX-31 **EX-31** -PN Sensor

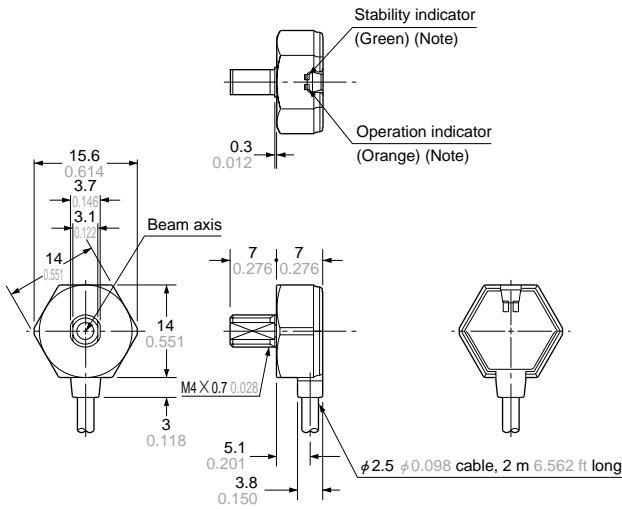

EX-32 **EX-32** -PN Sensor

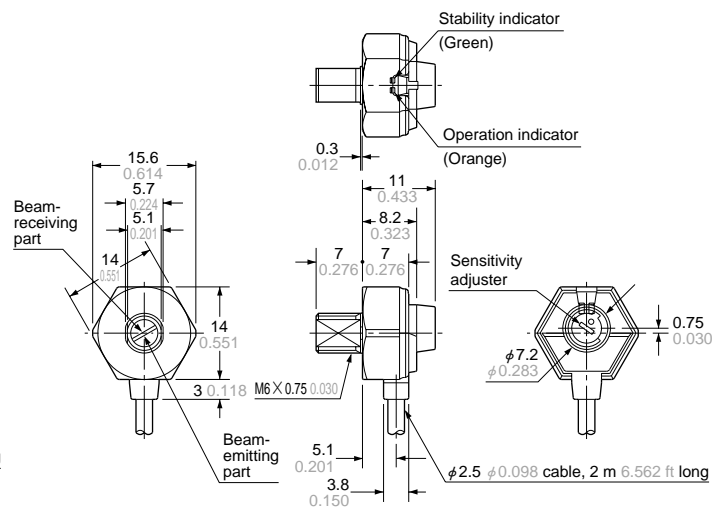

Note: Not incorporated on the emitter.

OS-EX30-1 Slit mask (optional)

Slit mask

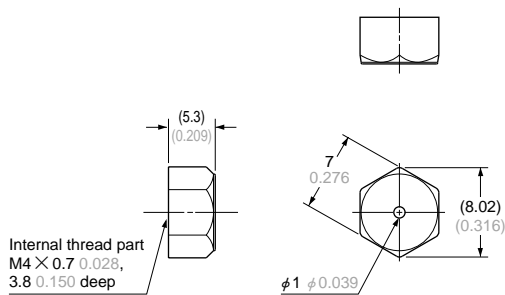

Material: Brass (Nickel plated)

Spacer



Material: POM